

Mat 10:34

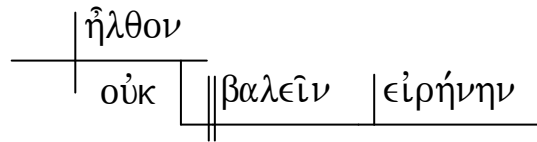

ἀλλὰ

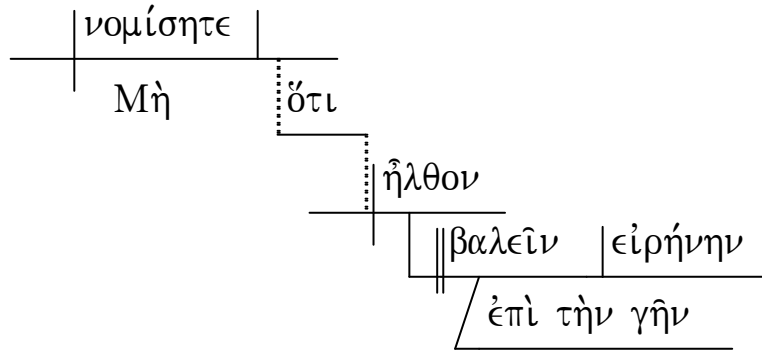

Mat 10:35

γάρ

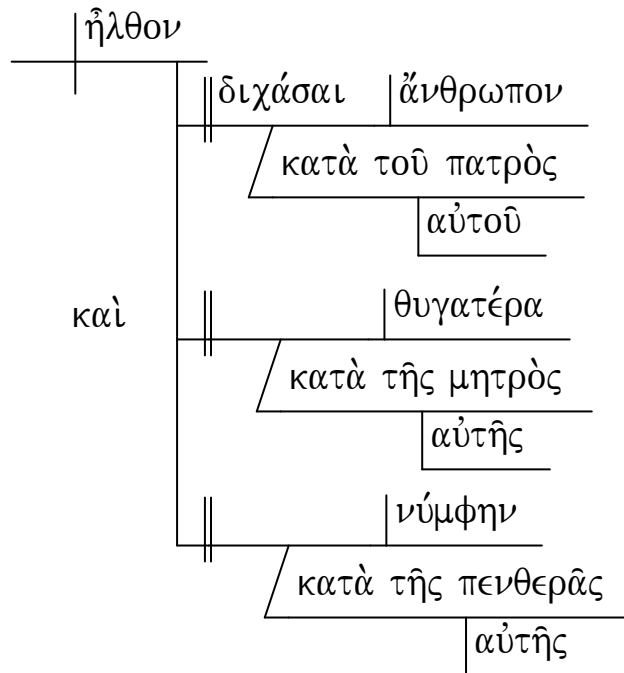

Mat 10:36

καὶ

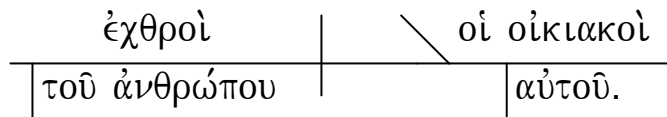

Mat 10:37

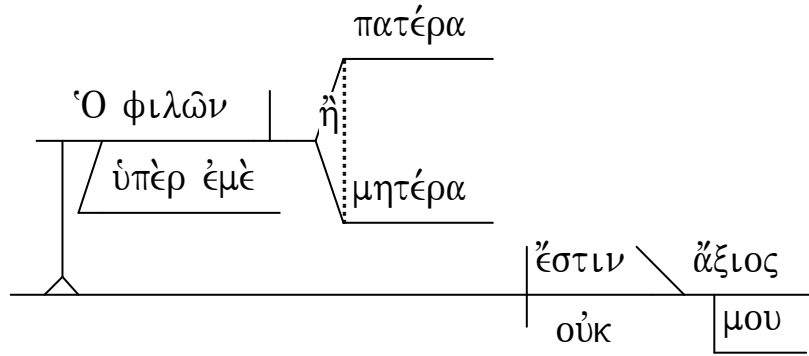

καὶ

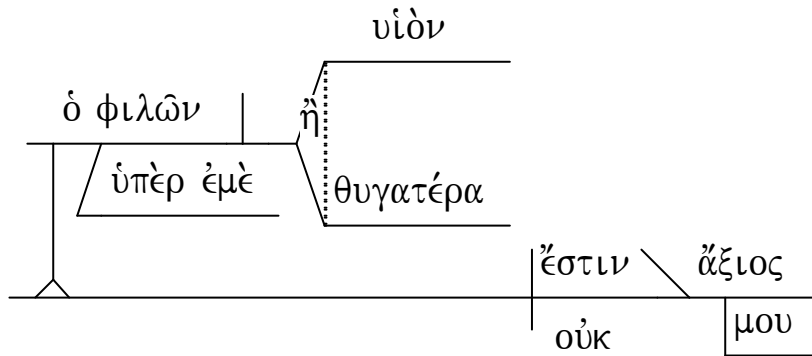

Mat 10:38

καὶ

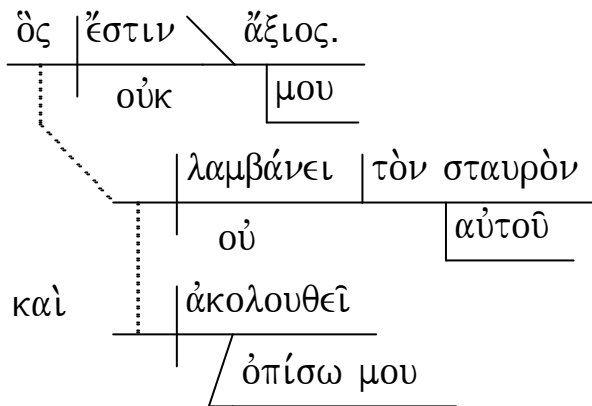

Mat 10:39

καὶ

